

# Albedino 1.0

# degré K

Montageanleitung • Mounting instruction • Instruction de montage • Istruzione di montaggio

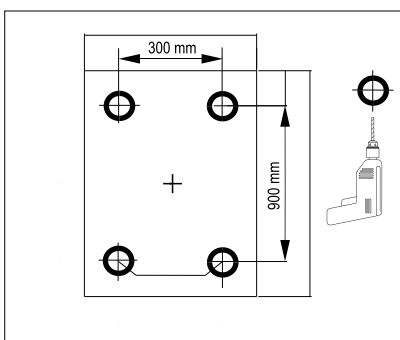
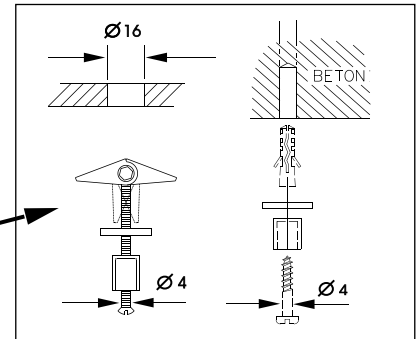
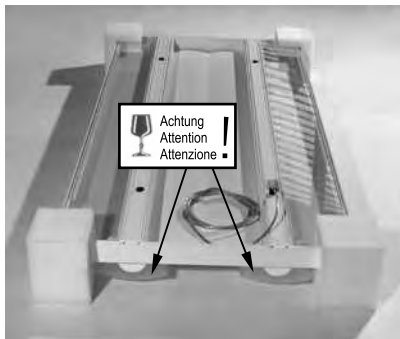
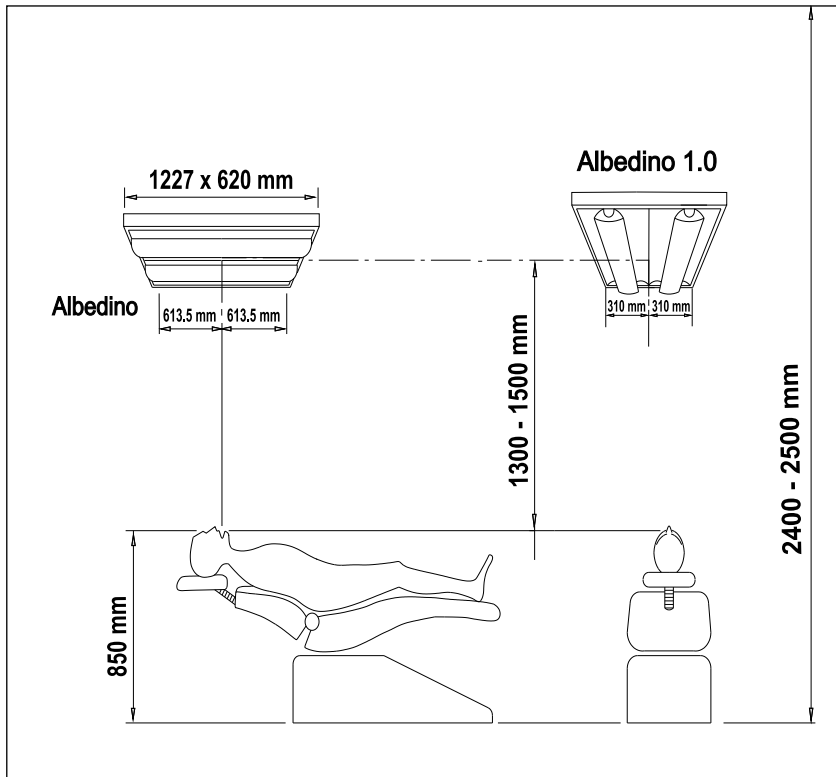

1

2

3

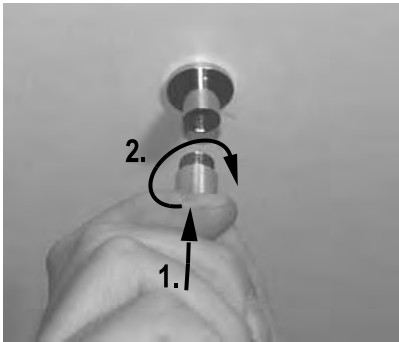

4



5

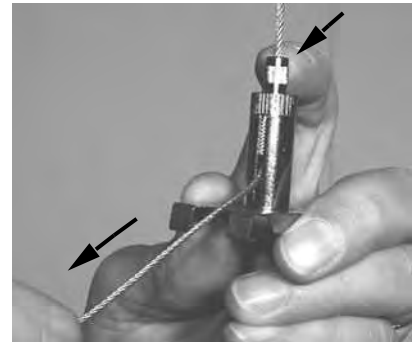

6



7



8

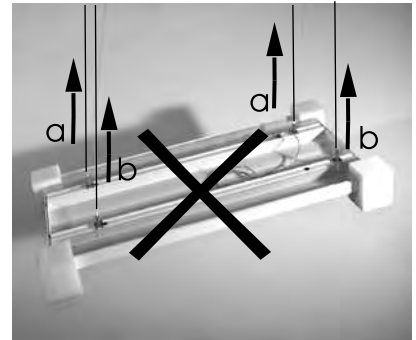

9

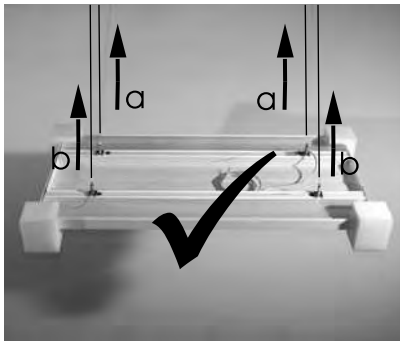

10

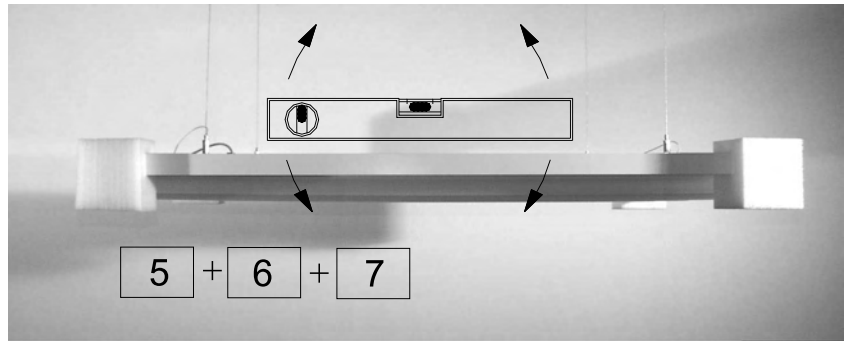

11

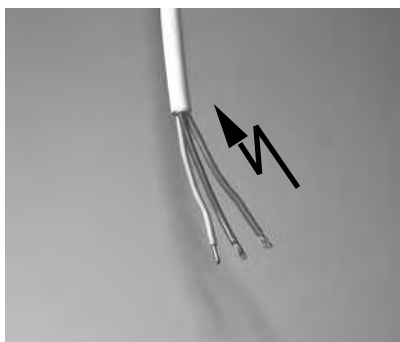

12

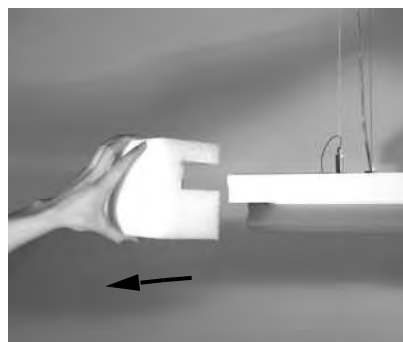

13

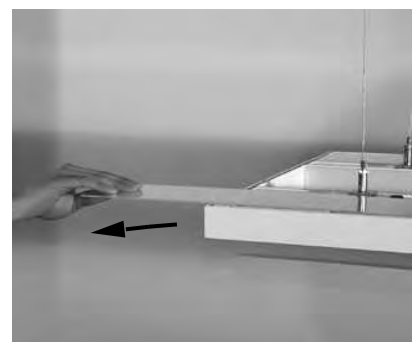

14

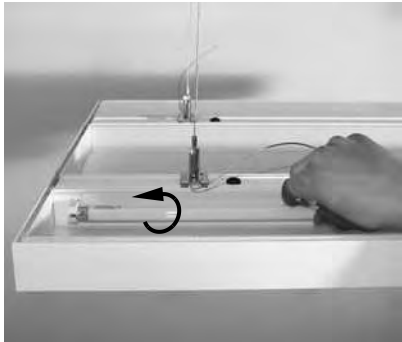

15

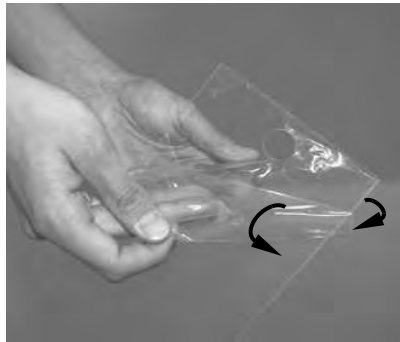

16

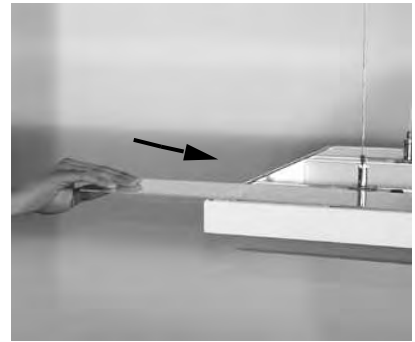

17

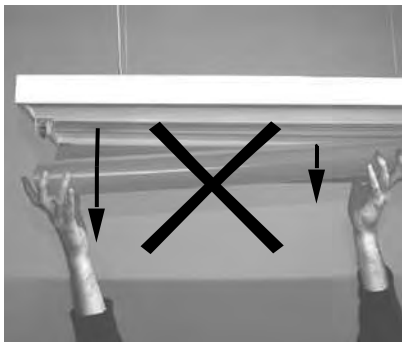

18

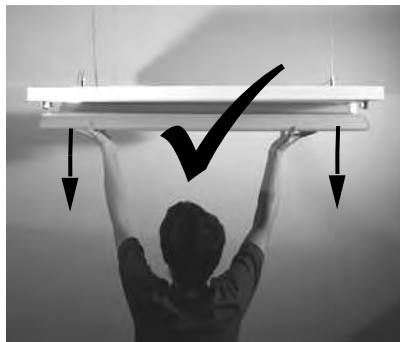

19

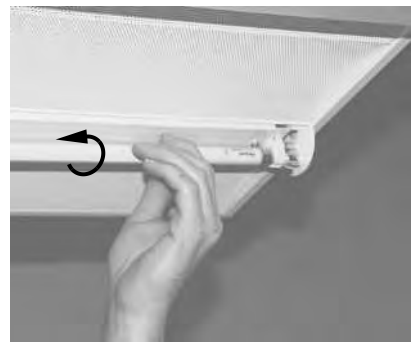

20

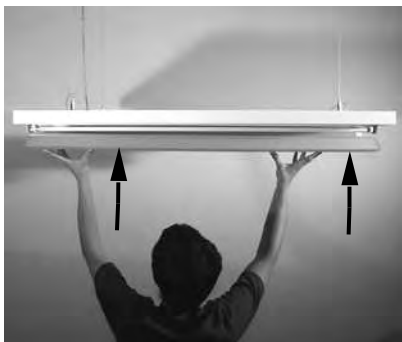

21

## Albédo 5 – Albédino 1.0

### Remplacement d'un ballast

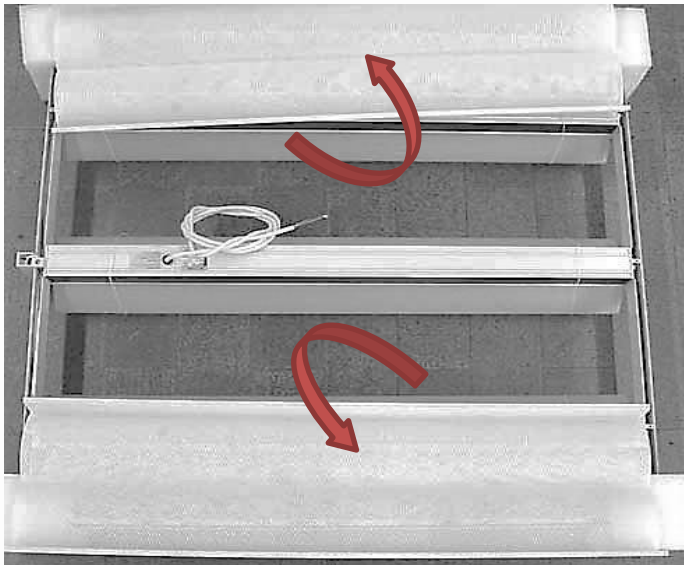

1. Déclipser les réflecteurs en métal perforé

Take off (clips off) the reflectors in pierced metal.



2. Enlever le couvercle latéral.

Take off the lateral cover.

3. Tirer le ballast vers l'extérieur.

Débrancher l'ancien ballast, rebrancher le nouveau selon le schéma de branchement du nouveau ballast.

Pull the ballast outside.

Disconnect the original ballast, and install the new ballast according to its wiring diagram.