



Albédo

v. S50.0 ON/OFF

v. S50.R Regul. Connect.



v. D65.0 ON/OFF

v. D65.R Regul. Connect.



FR INSTALLATION

EN INSTALLATION

DE MONTAGE

POSITIONNEMENT DU LUMINAIRE

LIGHTING FIXTURE POSITIONING

POSITIONIERUNG DER LEUCHTE

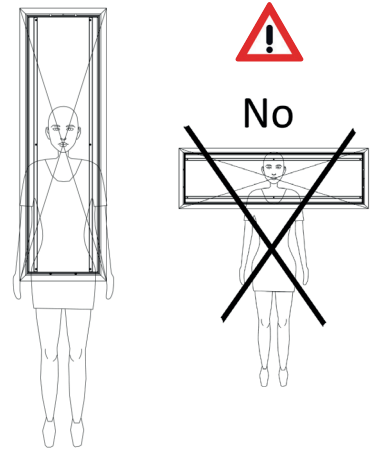
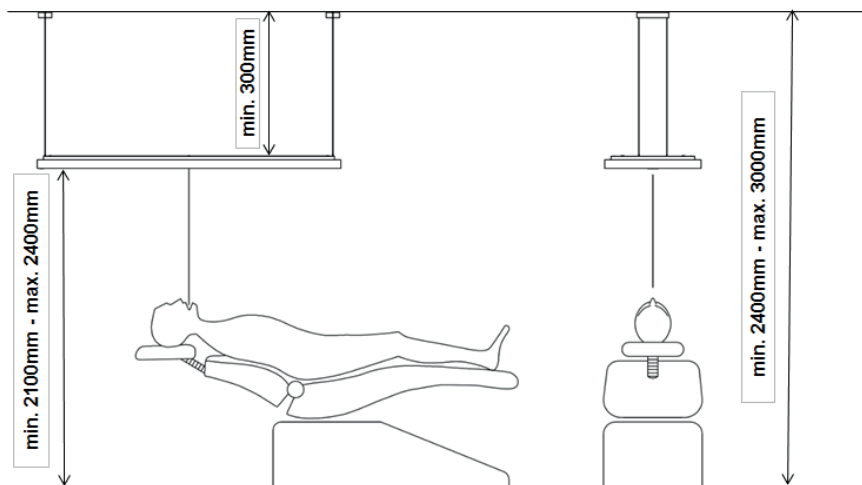

PREAMBULE

La notice d'installation ne remplace pas les réglementations locales et (inter)nationales des installations électriques.

- Le produit doit être installé suivant les codes électriques usuels et appropriés et selon les instructions fournies par degré K, pour éviter tout risque de combustion ou de choc électrique.
- Avant l'installation, la maintenance ou le nettoyage du produit, toujours couper l'alimentation au panneau principal.
- **Strictement respecter le câblage Terre** (fil au liseré vert-jaune discret, repéré par une étiquette).
- Déballez soigneusement le produit.
- Seul l'échange d'un Driver par une pièce d'origine est autorisé. **Ne jamais tenter d'accéder à l'intérieur du luminaire sous peine d'annuler la garantie.**
- Contacter Degré K ou le revendeur local pour obtenir une assistance technique.
- A conserver à température ambiante : -20°C à +45°C.

PREAMBLE

The installation instruction does not supersede local and (inter)national regulations for electrical installations.

- The product must be installed following applicable and appropriate electrical standards and according to the instructions provided by degré K in order to avoid any risks of fire or electrical shock.
- Before installation, maintenance or cleaning, always first turn off power to the circuit.
- **Strictly respect the Earth wiring** (wire with discreet green-yellow border, marked with a label).
- Carefully unpack the product.
- Only the exchange of a Driver for an original part is authorized. **Never attempt to access the interior of the luminaire since doing so may avoid the warranty.**
- Contact Degré K or the local reseller for technical assistance.
- Keep at an ambient temperature of: -20°C to +45°C.

PRÄAMBEL

Die Installationsanweisungen ersetzen nicht die lokalen und (inter)nationalen Vorschriften für elektrische Installationen.

- Das Produkt muss gemäß den üblichen und geeigneten elektrischen Vorschriften und gemäß den Anweisungen von Degré K installiert werden, um Verbrennungsgefahr oder Stromschlag zu vermeiden.
- Schalten Sie vor der Installation, Wartung oder Reinigung des Produkts immer die Stromversorgung am Hauptpanel aus.
- **Beachten Sie unbedingt die Erdungskabel** (Kabel mit diskretem grün-gelbem Rand, gekennzeichnet mit einem Etikett)
- Packen Sie das Produkt vorsichtig aus.
- Nur der Austausch eines Drivers gegen ein Originalteil ist zulässig. **Versuchen Sie niemals, das Innere der Leuchte da sonst die Garantie erlischt!**
- kontaktieren Sie bitte Degré K oder Ihren Händler, um technische Unterstützung zu erhalten.
- Bei Raumtemperatur lagern: -20 °C bis +45 °C.



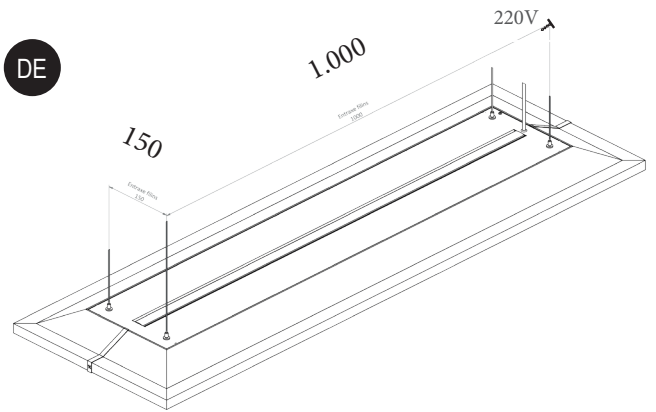

1

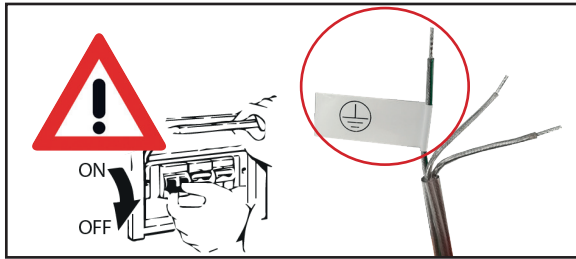

2

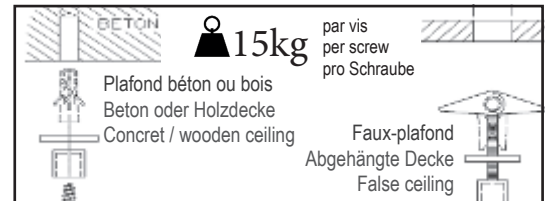

3



4

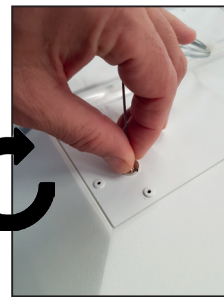
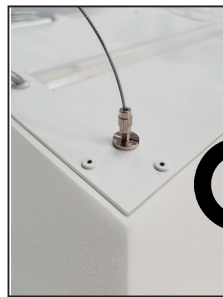
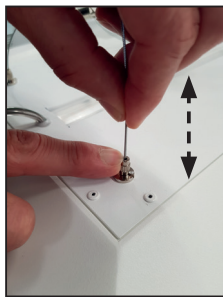

+



V. ALBÉDO S50.R :
V. ALBÉDO D65.R :



CASAMBI



FR MONTAGE SOUS FAUX PLAFOND

En cas de montage sur faux-plafond à dalles, voir procédure pour l'insertion des filins.

EN UNDER DROPPED CEILING

If mounting on a false ceiling with slabs, see procedure for inserting the cables.

DE MONTAGE UNTEN ZWISCHENDECKE

Bei der Montage an einer Zwischendecke mit Platten lesen Sie das Verfahren zum Einführen der Kabel.

FR ENTRETIEN

- Les diffuseurs sont résistants aux solutions désinfectantes non agressives.

Nettoyer avec une lingette douce de désinfection type Durr FD366, en frottant uniquement dans l'AXE LED à LED.

Après la période de désinfection, essuyer sans frotter avec un chiffon DOUX EN MICROFIBRE en respectant ce même axe.

- Les cadres sont suffisamment résistants aux solutions alcooliques type FD333 et FD322, mais les peintures de cadres peuvent être endommagées par d'autres solutions désinfectantes aqueuses.
- La peinture des cadres est sensible aux frottements exagérés.

EN CLEANING

- The light's diffusers are resistant to non-aggressive disinfectant solutions.

Clean with a soft disinfection wipe type Durr FD366, rubbing only on the LED-to-LED AXLE.

After the disinfection time has passed, wipe down the light using a clean, SOFT MICROFIBER cloth respecting the direction of the LEDs.

- The frames are sufficiently resistant to alcoholic solutions type FD333 and FD322 but the paint finish of the frames may be damaged by the use of other types of liquid cleaning solutions.
- The paint finish of the frames is sensitive to extreme scrubbing.

DE REINIGUNG

- Die Diffusoren sind beständig gegen nicht aggressive Desinfektionslösungen.

Mit einem weichen Desinfektionstuch (Typ Durr FD366) reinigen, ausschließlich an der LED-zu-LED-Richtung.

Nach der Desinfektion, trocknen sie ohne reibung ab. Trocken Sie mit einem WEICHEN MIKROFASERTUCH unter Berücksichtigung der Richtung der LEDs .

- Die Rahmen sind ausreichend resistent gegen alkoholische Lösungen vom Typ FD333 und FD322. Die Rahmenfarbe kann jedoch durch sonstige wasserhaltigen Desinfektionsmitteln beschädigt werden.
- Die Rahmenfarbe ist gegen starkes Reiben empfindlich.